

CROWN BOUNDARY MICROPHONE APPLICATION GUIDE

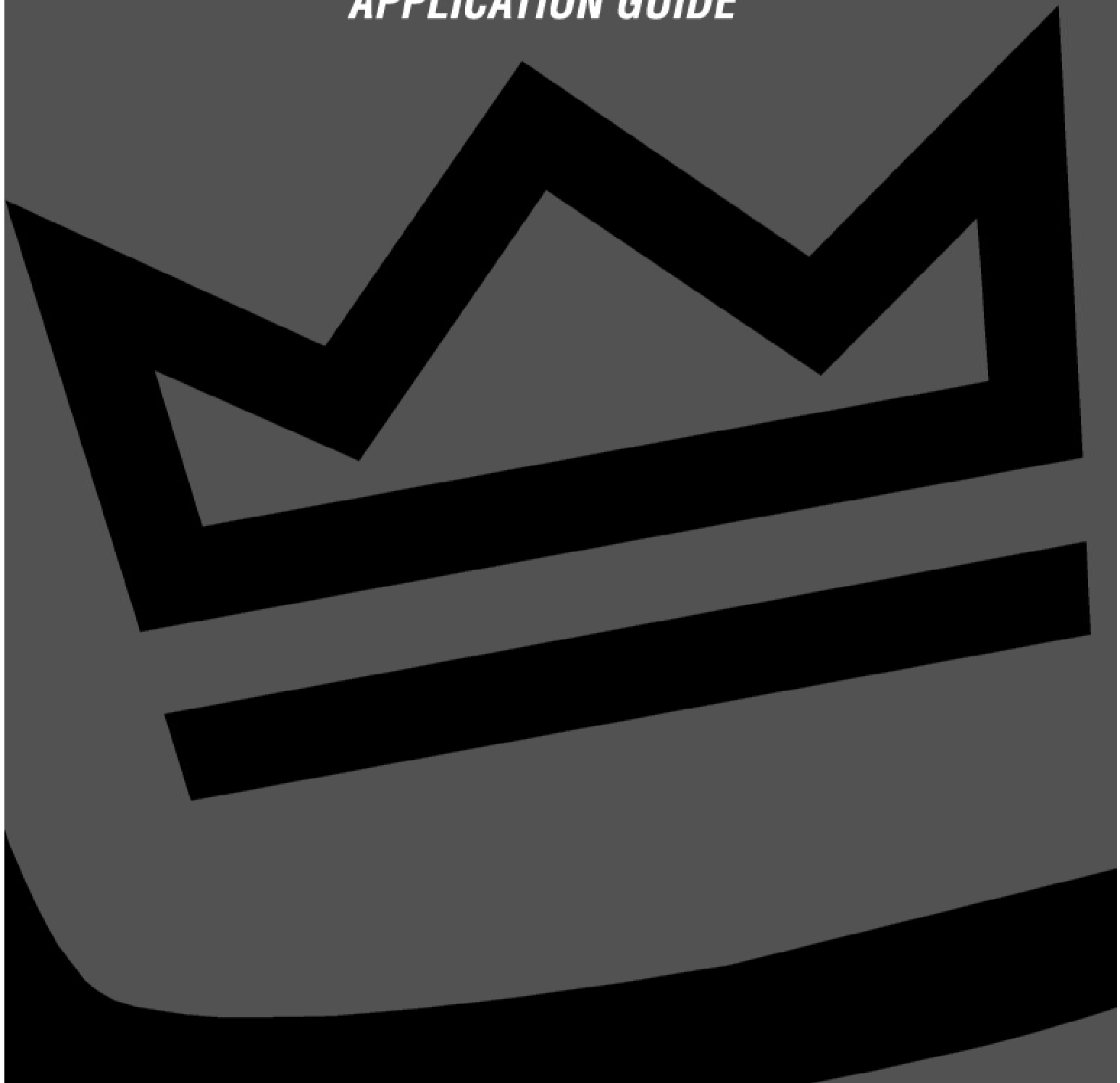

PZM, PCC, SASS AND BOUNDARIES

© 2000 Crown International, All rights reserved PZM[®], PCC[®], SASS[®] and DIFFEROID[®], are registered trademarks of Crown International, Inc. Also exported as Amcron[®]

127018-1
7/00



Crown International, Inc
P.O. Box 1000, Elkhart, Indiana 46515-1000
(219) 294-8200 Fax (219) 294-8329
www.crownaudio.com

Contents

Background to boundary microphones	1
How the boundary microphone works	2
The PCC microphone	3
Boundary microphone techniques for recording	4
Boundary microphone techniques for sound reinforcement	8
PZM boundaries	9
The SASS PZM stereo microphone	17
How to use the SASS microphone	20

INTRODUCTION

A boundary microphone is a miniature microphone designed to be used on a surface such as a piano lid, wall, stage floor, table, or panel. Mounting a miniature mic on a surface gives several benefits:

- A clearer, more natural sound quality
- Extra sensitivity and lower noise
- Consistent tone quality anywhere around the microphone
- Natural-sounding pickup of room reverberation

Crown boundary microphones include the PZM, PCC, MB, and SASS series microphones. This guide explains how they work and how to use them. For information on the CM, GLM, and LM models, please see the Crown Microphone Application Guide.

BACKGROUND

In many recording and reinforcement applications, the sound engineer is forced to place microphones near hard reflective surfaces. Some situations where this might occur are recording an instrument surrounded by reflective baffles, reinforcing drama or opera with the microphones near the stage floor, or recording a piano with the microphone close to the open lid.

When a microphone is placed near a reflective surface, sound travels to the microphone via two paths: (1) directly from the sound source to the microphone, and (2) reflected off the surface (as in Fig. 1-A). Note that the reflected sound travels a longer path than the direct sound, so the reflected sound is delayed relative to the direct sound. The direct and delayed sounds combine at the microphone diaphragm.

All frequencies in the reflected sound are delayed by the same time. Having the same time delay for all frequencies creates different phase delays for each frequency, because different frequencies have different wavelengths. For example, a time delay of 1 millisecond causes a 360-degree phase shift for a 1000-Hz wave, but only a 180-degree phase shift for a 500-Hz wave. Fig. 2 illustrates this point.

At frequencies where the direct and delayed sounds are in-phase (coherent), the signals add together, doubling the pressure and boosting the amplitude 6 dB. At frequencies where the direct and delayed signals are out-of-phase, the signals cancel each other, creating a dip or notch in the response. There results a series of peaks and dips in the net frequency response called a comb-filter effect, so named because the response looks like the teeth of a comb. (Fig. 1-B).

This bumpy frequency response colors the tonal reproductions, giving an unnatural sound. To solve this prob-

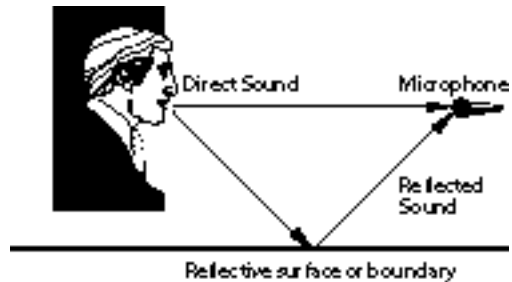

Fig. 1-A Microphone receiving direct sound and delayed reflected sound from a sound source

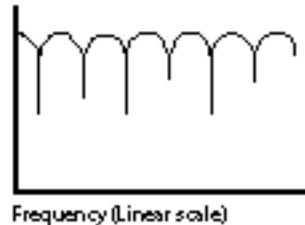

Fig. 1-B Resulting frequency response.

Fig. 1

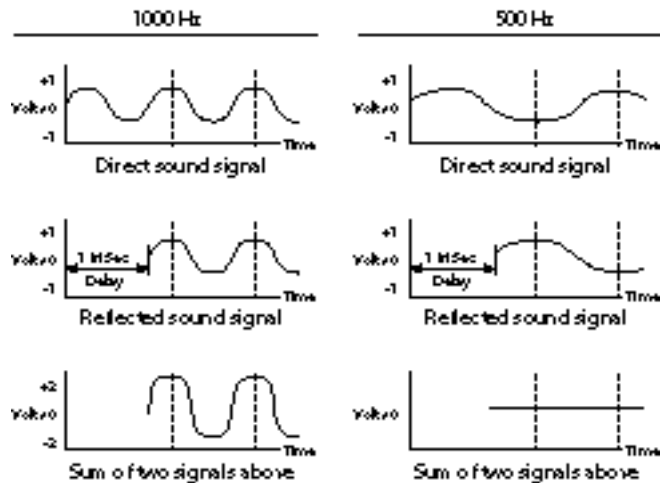

Fig. 2 - Example of wave addition and cancellation at two different frequencies.

lem, we need to shorten the delay of the reflected sound so that it arrives at the microphone at the same time the direct sound does.

If the microphone is placed on the reflective surface (as in Fig. 3), the direct and reflected sound paths become nearly equal. There is still a short delay in the reflected sound because the center of the microphone diaphragm (where the two sound paths combine) is slightly above the surface. Consequently, the high frequencies may be cancelled, giving a dull sound quality.

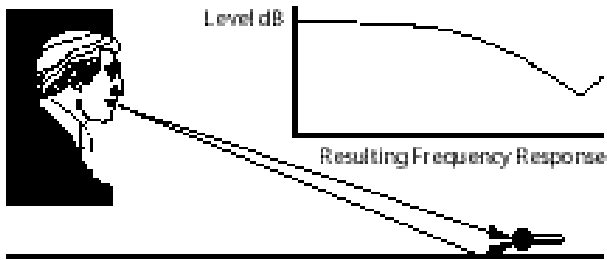

Fig. 3 - Conventional microphone on floor receiving direct sound and slightly delayed reflected sound.

HOW THE BOUNDARY MIC WORKS

By orienting the diaphragm parallel with the boundary (as in Fig. 4), the diaphragm can be placed as close to the boundary as desired. Then the direct and reflected waves arrive simultaneously at the microphone sound entry (the slit between the microphone diaphragm and the boundary). Any phase cancellations are moved outside the audible band, resulting in a smooth frequency response.

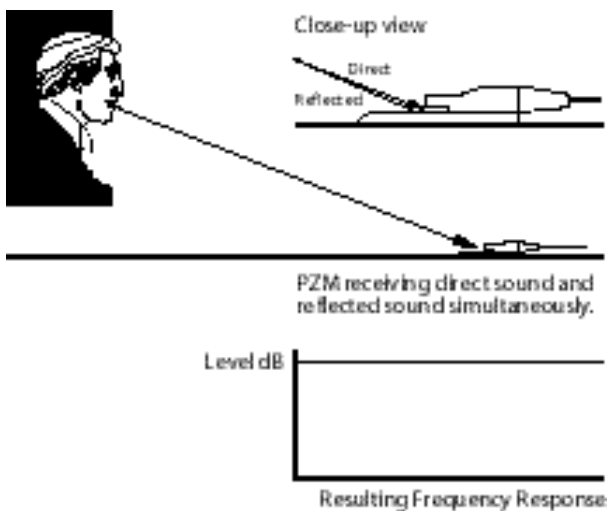

Fig. 4

The technique of mounting a microphone in this manner is called the Pressure Recording Process™ (invented by Ed Long and Ron Wickersham). They developed the first microphone to use this process. The first manufactured microphone using the principle was the Pressure Zone Microphone® (developed by Ken Wahrenbrock). PZM®s are now manufactured by Crown International, the first company licensed to build microphones using the Pressure Recording Process.

The Pressure Zone is the region next to the boundary where the direct and reflected waves are in-phase (or nearly so). There may be a slight phase shift between the direct and reflected waves, as long as the frequency

response is not severely degraded.

The Pressure Zone can be defined another way: The Pressure Zone is the distance from the boundary that the microphone diaphragm must be placed to achieve the desired high-frequency response. The closer the diaphragm is placed to the boundary (up to a point), the more extended is the high-frequency response. Let's show some examples.

For a frequency response down a maximum of 6 dB at 20 kHz, the mic-to-boundary spacing should be .11". Or you could say the Pressure Zone is .11" thick. This spacing corresponds to $\frac{1}{6}$ wavelength at 20 kHz.

For a response down 3 dB maximum at 20 kHz, the spacing should be .085" ($\frac{1}{8}$ wavelength at 20 kHz).

For a response down 1 dB maximum at 20 kHz, the spacing should be .052" ($\frac{1}{13}$ wavelength at 20 kHz).

Note that the thickness of the Pressure Zone is an arbitrary number depending on frequency. For example, the direct and reflected waves of a 100-Hz tone are effectively in-phase within a Pressure Zone 10" thick.

The Crown PZM microphone-to-boundary spacing is only .020", which relates to 1 dB down at 52 kHz.

Pressure doubling

As stated earlier, comb-filtering is eliminated when the direct and reflected waves add together in-phase. There is another benefit: the sound pressure doubles, giving a 6 dB increase in acoustic level at the microphone. Thus the effective microphone sensitivity increases 6 dB, and the signal-to-noise ratio also increases 6 dB.

Consistent tonal reproduction independent of source height

The microphone placements shown in Figs. 1 and 3 cause another problem in addition to rough response. As the sound source moves up or down relative to the surface, the reflected path length changes, which varies the comb-filter notch frequencies. Consequently, the effective frequency response changes as the source moves.

But with the PZM, the reflected path length stays equal to the direct path length, regardless of the sound-source position. There is no change in tone quality as the source moves.

Lack of off-axis coloration

Yet another problem occurs with conventional microphones: off-axis coloration. While a microphone may have a flat response to sounds arriving from straight ahead (on-axis), it often has a rolled-off or colored response to sounds arriving from other directions (off-axis).

That fault is mainly due to the size of the microphone and its forward orientation. When sound strikes the microphone diaphragm on-axis, a pressure boost occurs at

frequencies where the wavelength is comparable to the microphone diameter (usually above about 10 kHz). This phenomenon is called diffraction. Sounds approaching the microphone from the sides or rear, however, do not experience a pressure boost at high frequencies. Consequently, the high-frequency response is greater on-axis than off-axis. The frequency response varies with the position of the sound source.

Since the PZM capsule is very small, and because all sound enters the capsule through a tiny, radially symmetric slit, the response stays constant regardless of the angle at which sound approaches the microphone. The effective frequency response is the same for sounds from the front as it is for sounds from other directions. In other words, there is little or no off-axis coloration with the PZM. The reproduced tone quality doesn't change when the sound source moves.

As further benefit, the PZM has an identical frequency response for random-incidence sound as it has for direct sound. Direct sound is sound traveling directly from the source to the microphone; random incidence sound is sound arriving from all directions randomly. An example of random-incidence sound is ambience or reverberation – sounds reflected off the walls, ceiling, and floor of the recording environment.

With most conventional microphones, the response to reverberant, random-incidence sound is rolled off in the high frequencies compared to the response to direct sound. The direct sound may be reproduced accurately, but the reproduced reverberation may sound duller than in real life.

This fact leads to some problems in recording classical music with the microphones placed far enough away to pick up concert-hall ambience. The farther from the sound source the microphone is placed, the more reverberant is the sound pickup, and so the duller the sound is. The effective microphone frequency response may become duller (weaker in the high frequencies) as the microphone is placed farther from the sound source.

This doesn't occur with the PZM when it's used on the floor. The effective response stays the same regardless of the mic-to-source distance. The response to ambient sound (reverberation) is just as accurate as the response to the direct sound from the source. As a result, the total reproduction is brighter and clearer.

Reach

“Reach” is the ability to pick up quiet distant sounds clearly. “Clearly” means with a high signal-to-noise ratio, a wide smooth frequency response, and a high ratio of direct sound to reverberant sound.

As described earlier; the PZM has several performance attributes that contribute to excellent reach. The signal-to-

noise ratio is high because the signal sensitivity is boosted 6 dB by the on-surface mounting. The frequency response is wide and smooth because comb filtering is eliminated, and because reverberant sound is picked up with a full high-frequency response. The direct-to-reverberant sound ratio is high because the direct sound is boosted 6 dB near the surface, while the reverberant sound, being incoherent, is boosted only about 3 dB.

If the PZM element is mounted in a corner, the direct sound is boosted 18 dB, while reverberant sound is boosted only 9 dB. This gives the PZM a 9 dB advantage over a conventional omnidirectional microphone in the ratio of direct-to-reverberant sound. In other words, distant sources sound closer and clearer with the PZM than they do with a conventional omnidirectional microphone.

Low vibration sensitivity

The low mass and high damping of the PZM diaphragm make it relatively insensitive to mechanical vibrations such as table and floor thumps and clothing noise. The only pickup of these sounds is acoustic pickup through the air, not mechanical pickup through the microphone housing.

Small size

In addition to the acoustic benefits of the PZM, there are psychological benefits related to its low-profile design. Its inconspicuous appearance reduces “mic fright.” Since the PZM does not point at the performers, they may feel more relaxed in not having to aim their instruments at the microphone.

PZMs can be hidden in theatre sets. In TV-studio applications, the PZM practically disappears on-camera. PZMs reduce clutter on the conference tables and lecterns, giving the feeling that no microphones are in use.

THE PCC

The Phase Coherent Cardioid (PCC) is a surface-mounted supercardioid microphone which provides the same benefits previously mentioned for the PZM. Unlike the PZM, however, the PCC uses a subminiature supercardioid mic capsule. Its directional polar pattern improves gain-before-feedback, reduces unwanted room noise and acoustics, and rejects sound from the rear.

Fig. 5 shows the difference in construction and polar patterns of the PZM and PCC.

In the Crown PCC, the microphone diaphragm is small enough so that any phase cancellations are above the audible range (Fig. 6). This results in a wide, smooth frequency response free of phase interference. In contrast, the mic capsules in conventional microphones are relatively large. As a result, reflections are delayed enough to cancel high frequencies, resulting in dull sound (Fig. 3).

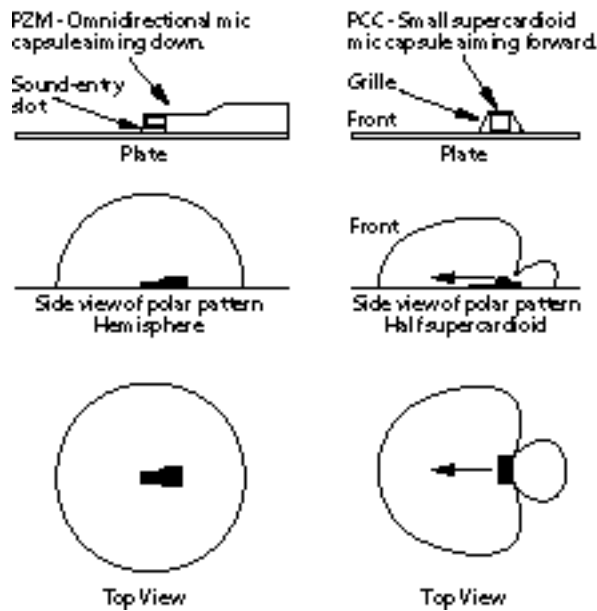

Fig. 5

Technically, the PCC is not a Pressure Zone Microphone. The diaphragm of a PZM is parallel to the boundary; the diaphragm of the PCC is perpendicular to the boundary. Unlike a PZM, the PCC “aims” along the plane on which it is mounted. In other words, the main pickup axis is parallel with the plane.

Because of its supercardioid polar pattern, the PCC has nearly a 6 dB higher direct-to-reverberation ratio than the PZM; consequently, distant sources sound closer and clearer with the PCC than with the PZM.

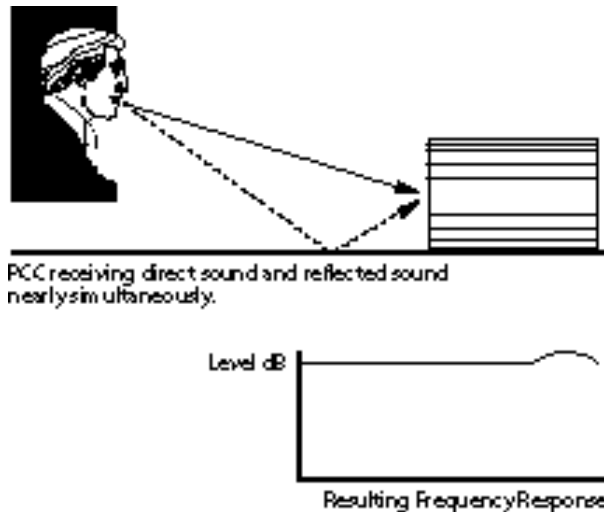

Fig. 6

BOUNDARY MICROPHONE TECHNIQUES FOR RECORDING

Before placing microphones, work on the “live” sound of the instrument or ensemble to be recorded. Do what you can to improve its sound in the studio.

To determine a good starting microphone position, close one ear with your finger; listen to the instrument with the other, and move around until you find a spot that sounds good. Put the PZM there, or put it on the floor or table at that distance.

Moving the microphone around the instrument will vary the tone quality, because an instrument radiates a different spectrum in every direction. Place the PZM to get the desired tone quality, then use equalization only if necessary. Note that the response of the PZM does not change with the angle of incoming sound, but the spectrum of the instrument does change depending on how it is aimed at the PZM.

To reduce pickup of acoustics, leakage from other instruments and background noise, move the PZM closer to the sound source. Mike only as close as necessary, since too-close placement may result in an unnatural tonal balance. Move the PZM farther from the source to add ambience or “artistic leakage” to the recording.

To further reduce pickup of unwanted sounds, mount the PZM on a large baffle or acoustic panel placed between the PZM and the offending noise source.

Use the smallest number of microphones that provide the desired sound; use as few as necessary. Sometimes this can be done by covering several sound sources with a single microphone. The wide polar pattern of the PZM allows you to pick up several instruments or vocalists on a single microphone with equal fidelity.

Follow the 3:1 rule: When multiple microphones are mixed to the same channel, the distance between the microphones should be at least three times the mic-to-source distance. This procedure reduces phase interference between the microphones. For example, if two microphones are each placed 2 feet from the instruments they cover, the mics should be at least 6 feet apart.

PZMs used in multiple-microphone applications may pick up a lot of leakage (“off-mic” sounds from other instruments). This leakage usually sounds good, however, owing to the PZM’s uncolored off-axis response. Artistic usage of leakage can add pleasing “liveliness” to the recording.

When a PZM is mounted on a wall, the wall becomes a part of the microphone. When a PZM is mounted in a corner, then all three walls become part of the microphone. The Pressure Zones of all the walls combine to reinforce the sound pickup. Use this fact to your advantage by mounting the PZM capsule at the junction of multiple boundaries whenever possible.

The following are some guidelines for PZM placement in various recording applications. Many were provided by users. Although these techniques have worked well in many situations, they are just suggestions.

Acoustic guitar, mandolin, dobro, banjo:

- On panel in front, about 2 feet away, guitar height.
- On panel in front and overhead to avoid interference with audience viewing.
- On floor (for soloist).

String section:

- On panel above and in front of the entire section.
- On panel midway between two instruments, about 6 feet high.

Fiddle or Violin:

- On panel in front or overhead.
- On music stand.

Cello or acoustic bass:

- On panel on floor, in front, tilted toward performer.
- On panel in front and above.
- On floor (for soloist).

String quartet:

- Spaced pair on floor about 3 to 6 feet apart.
- Spaced pair on panels in front and above, spaced 3 to 6 feet apart.

Harp:

- On panel about 2½ feet away, aiming toward treble part of sound board.

Sax, flute, clarinet:

- On panel in front and slightly above.
- On music stand.

Horns, trumpet, cornet, trombone:

- On wall, on hard-surface gobo, or on control-room window. Performers play to the wall or gobo a few feet away. Since their sound bounces off the wall back to them, they can hear each other well enough to produce a natural acoustic balance.
- On panel in front of and between every two players, 1 to 2 feet away.
- On music stand.
- Tuba – on panel overhead.

Grand Piano:

- Tape a PZM to the underside of the lid in the middle (Fig. 7). Put the lid on the long stick for best sound quality. To reduce leakage and feedback, put the lid on the short stick or close the lid and cover the piano with a heavy blanket.
- For stereo, use two PZMs taped under the lid – one over the treble strings near the hammers, one over the bass strings well away from the hammers. Microphone placement close to the hammers emphasizes attack;



Fig. 7

- placement far from the hammers yields more tone.
- To pick up the piano and room ambience with a single microphone, place a PZM on a panel about 6 to 8 feet from the piano, 4 feet high. Put the lid on the long stick, and face the panel at the piano with the panel perpendicular to the lid.
- To add ambience to a close-miked piano, mix in a PZM or two placed on a wall far from the piano.
- For singers who accompany themselves on a piano, mount two PZMs on opposite sides of a panel. Place the panel about where the music rack would be. For stereo, use a longer panel with two microphones on each side of the panel.

Amplifier/speaker for electric guitar, piano, bass:

- On panel in front of amp.
- On floor a few feet in front of amp. For an interesting coloration, add a panel a few feet behind the microphone.
- Inside the cabinet.

Leslie organ cabinet:

- Two PZMs on either side of the rotating horn, inside the top of the cabinet. Place another PZM inside the bottom cabinet.

Drum set:

- On panel or hard gobo, 1 to 2 feet in front of set, just above the level of the tom-toms. Use two microphones 3 feet apart for stereo. The drummer can balance the sound of the kit as he or she plays. Also hang a small-plate PZM vertically in the kick drum facing the beater head, with a pillow or blanket pressing against the beater head. The high sound pressure level will not cause distortion in the PZM's signal.
- Try two PZMs overhead, each mounted on a 1-foot square panel, angled to form a "V," with the point of the "V" aiming down. Omit the panel for cymbal miking.
- Two PZMs on a hard floor, about 2 feet to the left and right of the drummer.
- Tape a PZM to a gauze pad and tape the pad to the kick drum beater head near the edge. This mic will also pick up the snare drum.
- See percussion below.

Percussion:

- Use a PZM strapped to the chest of the player. The microphone is carried by the percussionist as he or she moves from instrument to instrument.

Xylophone, marimba, vibraphone:

- Use two PZMs above instrument, over bass and treble sides, with or without panels.

Lead Vocal:

- In the studio, mount a PZM on a wall, control-room window or panel a foot in front of the performer. The panel can be used in place of a music stand to hold the lyric sheet. Use the supplied foam windscreens to prevent “popping” sounds from the letter “P.”
- To reduce leakage in the vocal mic, (1) overdub the vocal, (2) use gobos, or (3) use a well-damped isolation booth with one hard wall to mount the PZM on. Note: the PZM does not have proximity effect (up-close bass boost). Use console EQ to add extra warmth if necessary.

Background harmony vocals:

- On a wall or panel.
- Use one or two on both sides of a gobo, with singers surrounding the gobo.

Combos, small groups:

For small musical groups with a good natural acoustic blend, such as bluegrass, old-time, ethnic groups, blues groups, or barbershop quartets.

- On floor—two for stereo about 3 to 5 feet apart (Fig. 8).
- On panels in front, or on panels on the floor, angled toward performers.

Drama, theatre, opera:

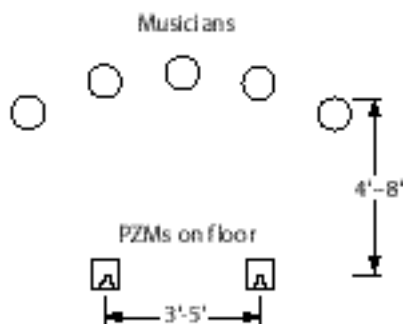

Fig. 8

- Try one to three PCCs across the front edge of the stage, about 1 foot from the edge of the stage (Fig. 9). One or two PCCs are usually sufficient for small stages, and they clearly pick up stage action for dressing room cues. Place two PCCs about 20 feet apart; place three PCCs about 15 feet apart.

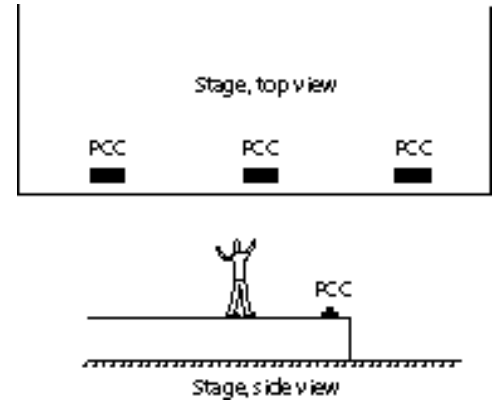

Fig. 9

For maximum clarity and maximum gain before feedback, turn up only the microphone nearest the person talking.

Show the performers and the custodian where the PCCs are located so they aren't kicked or mopped.

To reduce pickup of the pit orchestra, put a 2' x 2' piece of 4" thick Sonex foam about 1" behind each PCC.

The excellent “reach” of the PCC provides clear pickup of rear-stage action in most cases. But if you need extra reinforcement, place PZMs on the rear wall, on panels overhead, on a table under a table cloth, behind posts, under eaves, or on scenery.

Orchestra Pit:

- Tape two PZMs to the wall on either side of the conductor's podium, about 20 feet apart, facing each section of the orchestra.
- Use a separate PZM on a panel for each section of the orchestra.

Orchestra, marching band, jazz ensemble, pipe organ:

These large sound sources typically are recorded at a distance, using two microphones for stereo pickup.

- Mount a PZM 6 inches from the edge of a 2-foot square panel. Mount another PZM similarly on another panel. Tape together the panel edges nearest the microphones, forming a “V.” Aim the point of the “V” at the center of the sound source. Angle the panels about 70 degrees apart (as in Fig. 10). This assembly is called a PZM wedge.

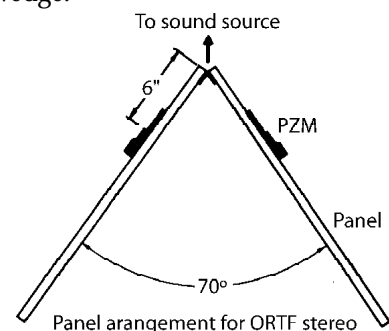

Fig. 10

The wedge can be suspended, or can be placed on edge on the floor, with the PZMs at the junction of the floor and the vertical panels (as in Fig. 11).

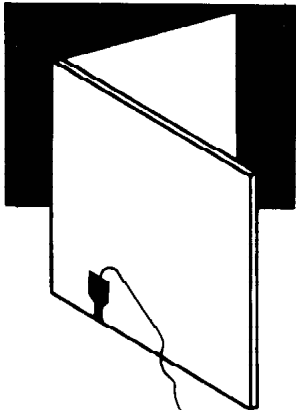

Fig. 11 - Near-coincident-stereo arrangement on floor

- Place two panel-mounted PZMs about 3 to 12 feet apart, 14 feet high, and 5 to 20 feet from the first row of players. Place the microphones farther apart to widen the stereo spread, closer together to narrow the spread.
- For noncritical documentary recordings, PZMs can be taped to the proscenium arch, the backstage wall, or the floor in front of the ensemble.

Choirs:

- Try two PZMs on panels, 5 feet above and 3 to 15 feet in front of the choir. Coverage is wide and the response is uncolored off-axis.
- For small choirs singing in an open area, place PZMs or PCCs on the floor in front of the group.
- For choirs seated on one side of a church chancel or small chapel facing the other side of the chancel or chapel, mount a PZM on the wall opposite the choir.

Ambience:

- One or two PZMs on the walls give an uncolored sound.
- One or two PZMs on the walls of an echo chamber provide ambient richness and naturalness.

Audience:

- On panels suspended over left and right sides of audience.
- Two PZMs on the front face of the stage about 4 feet apart.

Altars:

- Place a PZM or PCC on the altar table (perhaps under the table cloth).

Recording a conference:

Note: These suggestions are for recording, not for teleconferencing sound reinforcement. For teleconferencing sound reinforcement applications, see the Crown Microphone Application Guide for Teleconferencing and Distance Learning.

For maximum clarity, hold the conference in an acoustically “dead” room with carpeting, drapes, and acoustic-tile ceiling.

- Lay a single PZM in the middle of the table (Fig. 12).

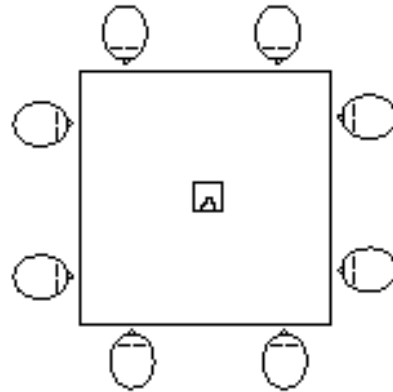

Fig. 12

- On a long table, use one PZM in the middle of every 4 to 6 people. No person should be more than 3 feet from the nearest microphone.
- For permanent installations, use the PZM-20R, a recessed microphone with all electronics and cabling under the table. Before installing it, first check that the pickup will be adequate by testing a regular PZM lying on the table.
- Try a PCC-170, a PCC-130 or a Mini Boundary mic at arm’s length for every one or two people.
- For more clarity, feed the PCCs into an automatic mixer.
- If table placement is undesirable, try mounting a PZM on the ceiling.
- Remove the plate from a PZM-6D. Install the capsule/holder in an upper corner of the room as in Fig. 13. This arrangement increases microphone output by 12 dB and gives surprisingly clear reproduction. Large rooms may require such a pickup in all four corners.

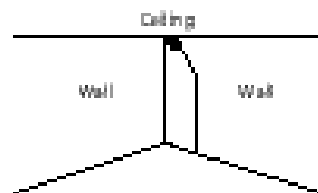

Fig. 13

Security/Surveillance:

- Try the ceiling or corner placements mentioned above.
- Use a PZM-10, PZM-10LL, PZM-11, or PZM-11LL. The PZM-10 flush-mounts in a ceiling or wall. The PZM-11 mounts in an electrical outlet box.

Lectern:

- Place a PCC on the lectern shelf top, outside of any cavities (Fig. 14). If the lectern has a raised edge, place the PCC at least twice as far from the edge as the edge is high. Set the BASS TILT switch to FLAT or BOOST, according to your preference.

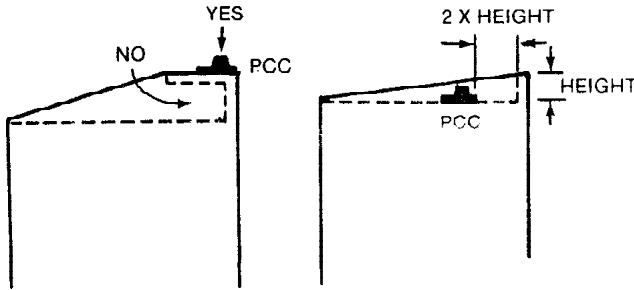

Fig. 14

- For lecterns with raised edges, you can modify your PZM as follows: remove the capsule holder by removing the two screws on the underside of the plate. Save the screws and plate for possible reassembly. Mount the capsule holder in the corner of the recess, with the holder pointing into the corner (as in Fig. 16). This configuration makes the pickup more directional but allows less talker wandering.

Fig. 15 shows how the frequency response of the PCC varies depending on where it is placed.

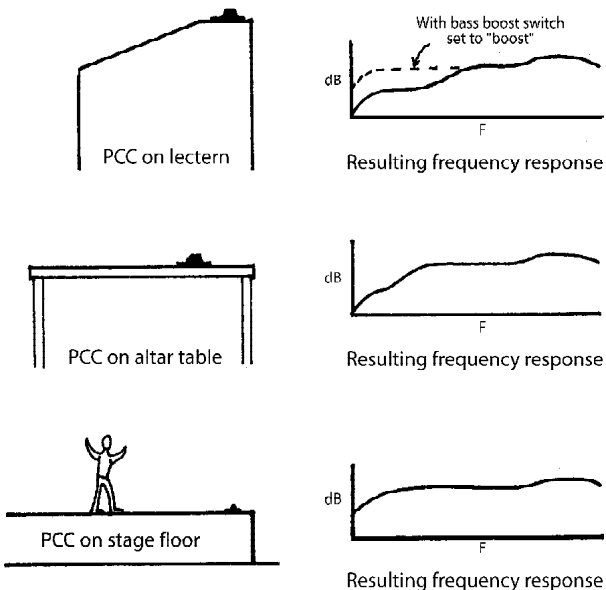

Fig. 15

Note: If you need to return the PZM for service, reattach the capsule/holder to the plate. The plate contains the identification number necessary for warranty service.

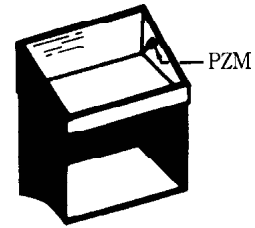

Fig. 16
Corner placement for lectern

Courtrooms:

- A PCC on the bench or witness stand can be permanently mounted and permits freedom of movement without lost speech. It provides excellent clarity and intelligibility. It also is far less intimidating to the witness than traditional microphones.

Sport events:

Basketball –

- On the basketball backboard under the hoop to pick up the sound of the ball hitting the backboard.
- On the floor just outside the boundary at center court to pick up foot and ball noises and audience reaction.
- On a 2' x 2' panel suspended over center court, using two PZMs on either side for stereo pickup.

Football –

- A PZM pyramid aimed at the field clearly picks up the quarterback calling the plays.

Boxing –

- Mount a PZM on a corner post or panel overhead.

Bowling –

- Place a PZM on the back wall of the alley, high enough to avoid being hit, to pick up the pin action.

Golf –

- Try a PZM on the ground near the tee. Insulate the mic from the ground to avoid ground loops.

Hockey –

- Tape a PCC-160 to a post, aiming down, to pick up action near the mic.

Indoor sports –

- Sports such as weight-lifting or fencing can be picked up with a PZM on the floor.

BOUNDARY MICROPHONE TECHNIQUES FOR SOUND REINFORCEMENT (P.A.)

Conventional Crown microphones (such as the LM, CM, and GLM series) work better than PZMs and PCCs for sound reinforcement of musical instruments and vocals. Please see the Crown Microphone Application Guide for suggestions on using conventional Crown microphones.

PZMs and PCCs can be used for sound reinforcement in many applications. These are described below.

Altar table:

- Place a PCC on the altar table as in Fig. 17. The PCC is available in black or white.

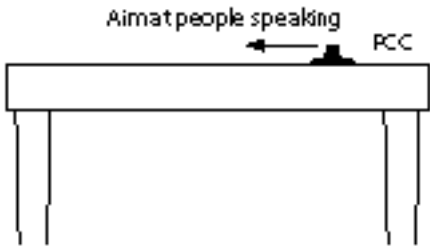

Fig. 17

Conferences, teleconferences, group discussions, interviews:

See the Crown Microphone Application Guide for Teleconferencing and Distance Learning.

Drama, theatre, musicals, opera

- Try one to three PCC-160s across the front edge of the stage, about 1 foot from the edge of the stage (Fig. 18). One or two PCCs are usually sufficient for small stages, and they clearly pick up stage action for dressing-room cues. Place two PCCs about 20 feet apart; place three PCCs about 15 feet apart.

For maximum clarity and maximum gain before feedback, turn up only the microphone nearest the person talking.

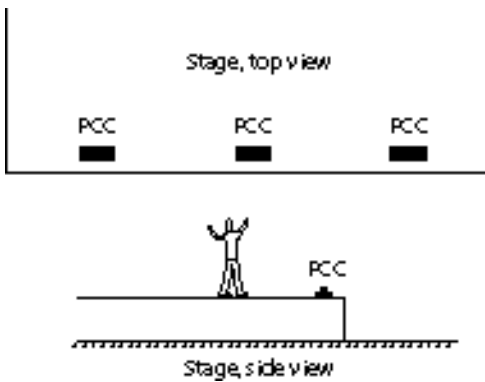

Fig. 18

Show the performers and the custodian where the PCCs are located so the PCCs are not kicked or mopped.

To reduce pickup of the pit orchestra, put a 2' x 2' piece of 4" thick Sonex foam about 1" behind each PCC.

The excellent reach of the PCC provides clear pickup of rear-stage action in most cases. But if you need extra reinforcement, place PZMs on the rear wall, on panels overhead, on a table under a tablecloth, behind posts, under eaves or scenery.

Courtroom proceedings:

- Place a PCC-170 or PCC-130 on the witness stand and judge's bench.

Horns

- Tape a PZM on the music stand above the sheet music.

Grand piano:

- Tape one or two PZMs or PCCs to the underside of the lid, about 8" horizontally from the hammers (see Fig. 19). To reduce feedback, close the lid.

Upright piano:

- Tape two PZMs 3' apart on the wall, 3' up. Place the piano frame 1" from the wall so that the PZMs pick up the soundboard.



Fig. 19

Drum set or percussion:

- Tape a PZM to the drummer's chest. Hang a PZM vertically in the kick drum with the microphone side of the plate aiming toward the beater.

PZM BOUNDARIES

You can greatly broaden your range of PZM® applications by mounting the PZMs on one or more boundaries. A boundary is a stiff, nonabsorbent surface such as a floor, table, or plexiglass panel. PZM boundaries are usually constructed of clear acrylic plastic (plexiglass) to make them less conspicuous, but any stiff, sound-reflective material can be used.

By adding boundaries to a PZM, you can tailor the microphone's frequency response and directional pattern. Such flexibility makes the PZM one of the world's most versatile microphones.

This section explains the theory, benefits and drawbacks of single and multiple boundaries. Also covered are construction methods for several types of PZM boundary assemblies.

Credit is due Ken Wahrenbrock for his pioneering work in multiple boundary experiments, and for many of the boundary array suggestions in this section.

A PZM is designed to be mounted very near a boundary to prevent acoustic phase cancellations. The boundaries

mentioned in this guide will degrade the frequency response and polar patterns of conventional microphones. Only PZMs can be used effectively in multiple boundaries.

The size, shape and number of boundaries all have profound effects on the performance of a PZM mounted on those boundaries. Let's discuss these effects in detail.

Sensitivity Effects

Imagine a PZM mic capsule in open space, away from any boundaries. This microphone has a certain sensitivity in this condition (Fig. 20).

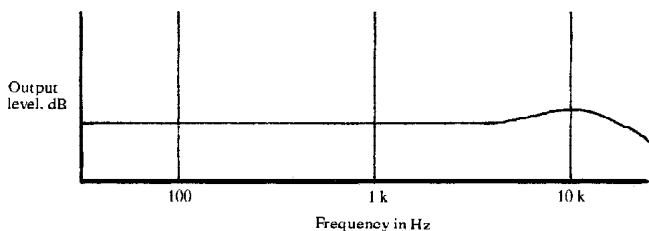

Fig. 20

Now suppose the PZM capsule is placed very near (within .020" of) a single large boundary, such as a wall. Incoming sound reflects off the wall. The reflected sound wave adds to the incoming sound wave in the "pressure zone" next to the boundary. This coherent addition of sound waves doubles the sound pressure at the microphone, effectively increasing the microphone sensitivity 6 dB.

In short, adding one boundary increases sensitivity 6 dB. This is free gain.

Now suppose the PZM capsule is placed at the junction of two boundaries at right angles to each other, such as the floor and a wall. The wall increases sensitivity 6 dB, and the floor increases sensitivity another 6 dB. Thus, adding two boundaries at right angles increases sensitivity 12 dB.

Now let's place the PZM element at the junction of three boundaries at right angles, such as in the corner of the floor and two walls. Microphone sensitivity will be 18 dB higher than what it was in open space. This is increased gain with no increase in noise!

Note that the acoustic sensitivity of the microphone rises as boundaries are added, but the electronic noise of the microphone stays constant. Thus, the effective signal-to-noise ratio of the microphone improves 6 dB every time a boundary is added at right angles to previous boundaries.

If a PZM is in the corner of three boundaries that are NOT at right angles to each other, the sensitivity increases less than 6 dB per boundary. For example, a PZM-2.5 boundary is built with two panels at 135 degrees. This panel assembly is at right angles to a base

plate. The net gain in sensitivity from these three boundaries is approximately 16 dB rather than 18 dB.

Direct-to-Reverb Ratio Effects

We mentioned that sensitivity increases 6 dB per boundary added. That phenomenon applies to the direct sound reaching the microphone. Reverberant or random-incidence sound increases only 3 dB per boundary added. Consequently, the direct-to-reverb ratio increases 3 dB (6-3dB) whenever a boundary is added at right angles to previous boundaries.

A high direct-to-reverb ratio sounds close and clear; a low direct-to-reverb ratio sounds distant or muddy. Adding boundaries increases the direct-to-reverb ratio, so the subjective effect is to make the sound source audibly closer or clearer. That is, "reach" is enhanced by adding boundaries.

Frequency-Response Effects

The size of the boundary on which the PZM is mounted affects the PZM's low-frequency response. The bigger the boundary, the better the bass. Specifically, the response begins to shelf down 6 dB at the transition frequency F_T , where

$$F_T = 750/D$$

D is the boundary dimension in feet. The response is down 6 dB at the frequency F_{-6} where

$$F_{-6} = 188/D$$

For example, if the boundary is 2 feet square,

$$F_T = 750/D = 750/2 = 375 \text{ Hz.}$$

$$F_{-6} = 188/D = 188/2 = 94 \text{ Hz.}$$

That is, the microphone starts to shelf down at 376 Hz and is down 6 dB at and below 94 Hz. (See Fig. 21).

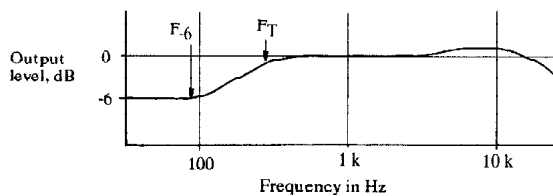

Fig. 21

Below 94 Hz, the response is a constant 6 dB below the upper-mid frequency level. Note that there is a response shelf, not a rolloff.

If a PZM is mounted on a 4' square boundary,

$$F_T = 750/4 = 187.5 \text{ Hz}$$

$$F_{-6} = 188/4 = 47 \text{ Hz.}$$

This result has been loosely called the "4' - 40 Hz" rule. Fig. 22 shows the PZM response on various sizes of boundaries.

What if the PZM is on a rectangular boundary? Let's call the long side " D_{max} " and the short side " D_{min} ." The response is down 3 dB at $188/D_{max}$, and is down another 3 dB at $188/D_{min}$.

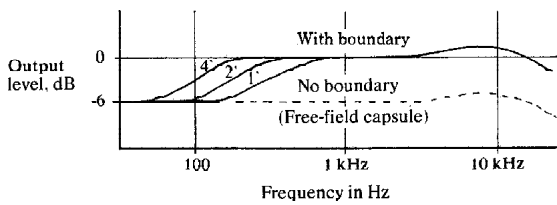

Fig. 22

As Fig. 23 shows, the low-frequency shelf varies with the angle of the sound source around the boundary. At 90 degrees incidence (sound wave motion parallel to the boundary), there is no low-frequency shelf.

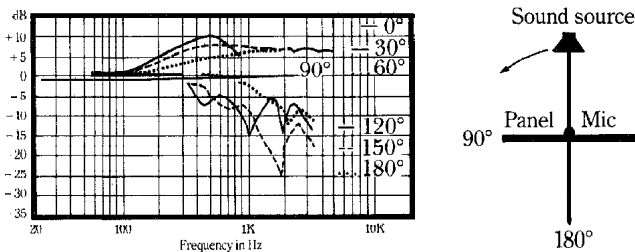

Fig. 23

The depth of the shelf also varies with the distance of the sound source to the panel. The shelf starts to disappear when the source is closer than a panel dimension away. If the source is very close to the PZM mounted on a panel, there is no low-frequency shelf; the frequency response is flat.

If the PZM is at the junction of two or more boundaries at right angles to each other, the response shelves down 6 dB per boundary at the frequency mentioned above. For example, a two-boundary unit made of 2-foot square panels shelves down 12 dB at and below 94 Hz.

There are other frequency-response effects in addition to the low-frequency shelf. For sound sources perpendicular to the boundary, the response rises about 10 dB above the shelf at the frequency where the wavelength equals the boundary dimension (see Fig. 23).

For a square panel, $F_{\text{peak}} = .88C/D$, where C = the speed of sound (1130 feet per second) and D = the boundary dimension in feet. For a circular panel, $F_{\text{peak}} = C/D$. As example, a 2' square panel has a 10 dB rise above the shelf at $.88C/D = 88 \times 1130/2 = 497$ Hz.

Note that this response peak is only for the direct sound of an on-axis source. If the sound field at the panel is partly reverberant, or if the sound waves strike the panel at an angle, the effect is much less. The peak is also reduced if the mic capsule is placed off-center on the boundary.

Fig. 23 shows the frequency response of a PZM mounted on a 2' square panel, at various angles of sound incidence. Note several phenomena shown in the figure:

- The low-frequency shelf (most visible at 30 and 60 degrees).
- The lack of low-frequency shelving at 90 degrees (grazing incidence).
- The 10 dB rise in response at 497 Hz.
- Less interference at increasing angles up to 90°.
- Greater rear rejection of high frequencies than low frequencies.

What are the acoustic causes of these frequency-response effects?

When sound waves strike a boundary, pressure doubling occurs at the boundary surface, but does not occur outside the boundary. Thus there is a pressure difference at the edge of the boundary. This pressure difference creates sound waves.

These sound waves generated at the edge of the boundary travel to the microphone in the center of the boundary. At low frequencies, these edge waves are opposite in polarity to the incoming sound waves.

Consequently, the edge waves cancel the pressure doubling effect.

Thus, at low frequencies, pressure doubling does not occur; but at mid-to-high frequencies, pressure doubling does occur. The net effect is a mid-to-high frequency boost, or – looked at another way – a low-frequency loss or shelf.

Incoming waves having wavelengths about six times the boundary dimensions are cancelled by edge effects; waves of wavelength much smaller than the boundary dimension are not cancelled by edge effects.

Waves having wavelengths on the order of the boundary dimensions are subject to varying interference vs. frequency; i.e., peaks and dips in the frequency response.

At the frequency where the wavelength equals the boundary dimension, the edge wave is in phase with the incoming wave. Consequently, there is a response rise (about 10 dB above the low-frequency shelf) at that frequency. Above that frequency, there is a series of peaks and dips that decrease in amplitude with frequency.

The edge-wave interference decreases if the incoming sound waves approach the boundary at an angle.

Interference also is reduced by placing the mic capsule off-center. This randomizes the distances from the edges to the mic capsule, resulting in a smoother response.

Directional Effects

The polar pattern of a PZM on a large surface is hemispherical. The microphone picks up equally well in any direction above the surface plane, at all frequencies.

By adding boundaries adjacent to this PZM, you can shape its directional pickup pattern. Boundaries make

the PZM reject sounds coming from behind the boundaries. In addition, making the PZM directional increases its gain-before-feedback in live reinforcement applications. Directional PZMs also pick up a higher ratio of direct sound to reverberant sound, so the resulting audio sounds “closer” and “clearer.”

In general, sound pickup is fairly constant for sound sources at any angle in front of the boundaries, and drops off rapidly when the source moves behind the boundaries.

For sounds approaching the rear of the panel, low frequencies are rejected least and high frequencies are rejected most.

A small boundary makes the PZM directional only at high frequencies. Low frequencies diffract or bend around a small boundary as if it isn't there. The bigger you can make the boundary assembly, the more directional the microphone will be across the audible band.

The bigger the boundary, the lower the frequency at which the PZM becomes directional. A PZM on a square panel is omnidirectional at very low frequencies, and starts to become directional above the frequency F , where $F = 188/D$ and D is the boundary dimension in feet. Sound familiar? That's the same equation used to predict the 6-dB-down point in the frequency response.

Boundaries create different polar patterns at different frequencies. For example, a 2' square panel is omnidirectional at and below 94 Hz. At mid-frequencies, the polar pattern becomes supercardioid. At high frequencies, the polar pattern approaches a hemisphere (as in Fig. 24). Two boundaries are more directional than one, and three are more directional than two.

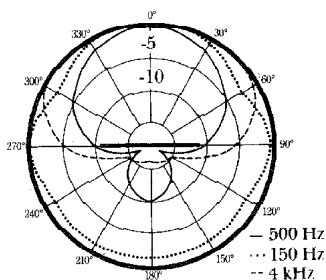

Fig. 24 – Polar response of 2-foot square boundary

With multiple boundaries, the shape of the pickup pattern approximates the shape of the boundary assembly. For example, a V-shaped boundary produces a polar pattern with a lobe whose sides are defined by the sides of the “V.” Note, however, that the polar pattern varies with frequency.

This “V”-shaped boundary works like a horn loudspeaker in reverse. Speaker horn theory applies to microphone horns. For instance, if you want a constant

directivity boundary horn, the horn must flare out exponentially like a well-designed loudspeaker horn.

Disadvantages of Boundaries

Boundaries must be large to be effective. Their size and weight makes them cumbersome to mount or hang. Large boundaries are also visually conspicuous, but this problem is reduced by using clear plastic.

Many users claim that the sound quality and flexibility if multiple-boundary PZMs outweigh the disadvantages. For those users who need a directional PZM but prefer not to use boundaries, Crown makes the PCC®-160 and PCC-170, which are supercardioid surface-mounted microphones. They use a directional mic capsule, rather than boundaries, to make the microphone directional. The PCC-130 is cardioid.

Summary

- Microphone sensitivity increases 6 dB for every boundary added at right angles to previous boundaries (less than 6 dB if not at right angles).
- For a flat panel, the frequency response begins to shelf down at the transition frequency $F_T = 720/D$, where D = boundary dimension in feet. The response shelves down 6 dB at and below the frequency $F_{-6} = 188/D$. This shelf disappears if the sound source is at the side of the panel, or if the source is very close to the microphone (less than a panel dimension away).
- For a square panel, the frequency response rises about 10 dB above the low-frequency shelf (when the source is perpendicular to the boundary) at the frequency $F = .88C/D$, where C = the speed of sound (1130 fps) and D = the boundary dimension in feet.
- The PZM/panel assembly is omnidirectional at and below the frequency $F = 188/D$, where D = the boundary dimension in feet. The panel becomes increasingly directional as frequency increases.
- Use the biggest boundaries that are not visually conspicuous. Big boundaries provide flatter response, better bass, and more directionality than small boundaries.
- The flattest response for a single panel occurs for angles of incidence between 30° and 90° to the axis perpendicular to the boundary.
- For the flattest response, place the PZM 1/3 of the way off-center (say, 4" off-center for a 2' panel). For flattest response on multiple boundaries, place the tip of the PZM cantilever touching against the boundaries (leaving the usual gap under the mic capsule).
- To increase directionality and reach, increase boundary size or add more boundaries.

Construction Tips

You can obtain clear acrylic plastic (plexiglass) from a hardware store, plastic supplier or a fabrication company. Plastic 1/4" thick is recommended for good sound

rejection. Many vendors can heat and shape the plastic according to your specifications. They use their own adhesives which are usually proprietary.

Cyanoacrylate adhesive (“Super Glue”) or RTV (“Sealastic”) have worked well in some instances. Or you can join several pieces of plastic with metal brackets, bolts and nuts.

If you intend to hang or “fly” the boundary assembly, drill holes in the plastic for tying nylon line. To prevent cracks in the plastic, use ceramic drill bits or start with small drill-bit sizes and work up. You may want to paint the boundary edges flat black to make them less visible.

When making a multi-boundary assembly, be sure to mount the PZM mic capsule as close as possible to the junction of the boundaries. Let the tip of the cantilever touch the plastic, but leave the usual gap under the mic capsule.

NOTE: Some older PZMs include a small block of foam under the mic capsule for acoustical adjustment. If your PZM has this foam block, trap it under the mic capsule before screwing the PZM cantilever to the boundary.

The PZM model used for multi-boundary assemblies is the PZM-6D. When drilling the screw holes for the cantilever, make them 5/32" diameter, .563" center-to-center, and countersunk .250" x 90°.

2-Foot-Square Flat Panel

This boundary (Fig. 25) is most often used for directional pickup of solo instruments, choirs, orchestras, and bands. Two PZMs back-to-back on a panel form a “bipolar” PZM for coincident stereo. Place the assembly about 14 feet above the stage floor.

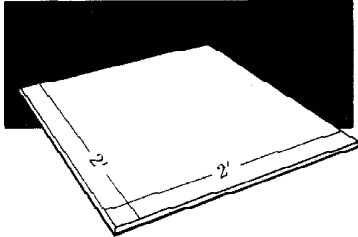

Fig. 25 – A two-foot square flat panel

For near-coincident stereo miking, place two panels with edges touching to form a “V” (Fig. 10). Aim the point of the “V” at the sound source. Mount a PZM about 4" off-center on each panel, toward the point of the “V” for better stereo imaging. This assembly provides a higher direct-to-reverb imaging. This assembly provides a higher direct-to-reverb ratio (a closer perspective) than the bipolar PZM mentioned above. It also rejects sounds approaching the rear of the panels.

The frequency response of a flat panel is the smoothest of all the boundary assemblies in this booklet. For a 2-foot square panel, there is a 10-dB rise above the low-

frequency shelf at 497 Hz for direct sound at normal incidence (Fig. 23). $F_{-6}=94$ Hz.

The polar pattern is omnidirectional at low frequencies, supercardioid at mid frequencies, and hemispherical at high frequencies (see Fig. 26).

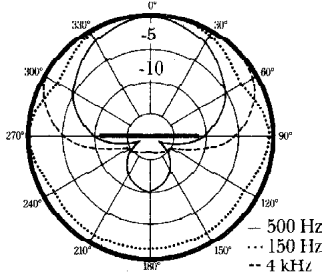

Fig. 26 – Polar response of a 2 foot-square boundary.

Random Energy Efficiency = -3 dB at high frequencies. The assembly has 3 dB less reverb pickup than an omnidirectional microphone in open space at the same distance.

Distance factor = 1.41. That is, the microphone/panel can be placed 1.41. times as far from the source as an omnidirectional microphone for the same direct-to-reverb ratio.

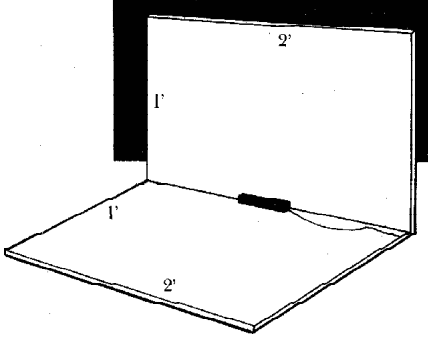

Fig. 27 – PZM-2

PZM-2

This model uses two panels at right angles to each other. One of the panels is placed on a large flat surface such as a table or floor.

One configuration uses a 1'x2' vertical panel. When this vertical panel is placed on a horizontal surface, the vertical panel is “reflected” in the horizontal surface. The panel and its reflection appear to be a 2'x2' panel with a 94-Hz shelving frequency.

Random Energy Efficiency = -6 dB. The assembly has 6 dB less reverb pickup than an omnidirectional mic in open space as the same distance.

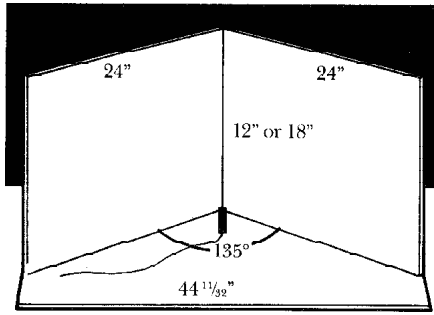

Fig. 30 – PZM 2.5

PZM-2.5

This model provides about 10 dB of forward gain at mid frequencies compared to a PZM on the floor. The assembly is placed on a large horizontal surface such as a stage floor.

An 18" tall unit works well for speech pickup of drama, musicals, and opera; cello, string bass, and kick drum.

$F_{-6} = 160$ Hz for 12" tall model. Polar pattern (12" model): See Figs. 28 and 29.

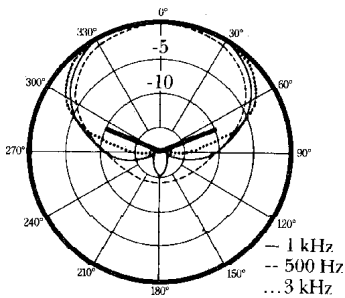

Fig. 28 – 12" tall PZM-2.5: horizontal-plane polar response.

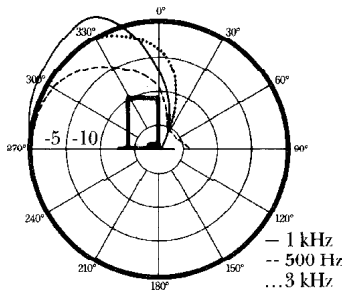

Fig. 29 – 12" tall PZM-2.5: vertical plane polar response.

PZM-3

This model has a tighter polar pattern than the PZM-2.5, so it can be used to isolate soloists. Again, the assembly is placed on a large horizontal surface such as a stage floor.

F_{-12} (two 1' square panels on floor) = 94 Hz.

Random Energy Efficiency = -9 dB. The assembly has 9 dB less reverb pickup than an omnidirectional microphone in open space at the same distance.

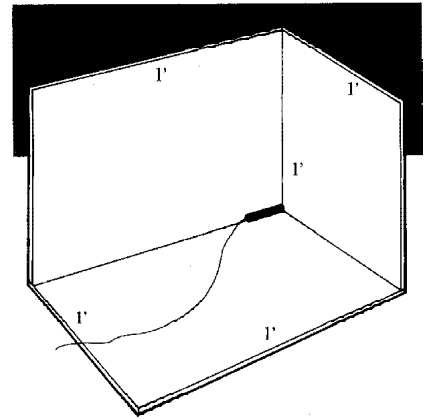

Fig. 31 – PZM 3

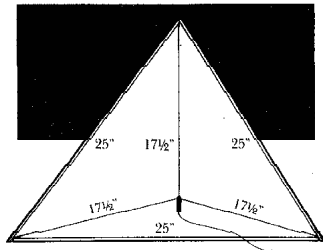

Fig. 32 – PZM Pyramid

PZM Pyramid

This model can be made of three or four sides. It emphasizes mid frequencies and is recommended only for speech. Its highly directional pattern makes it useful for long-distance pickup of quarterback calls. Pyramids also have been hung over stages for pickup of rear-stage dialog.

Since a plexiglass pyramid can be quite heavy, you may want to make it out of sheet metal.

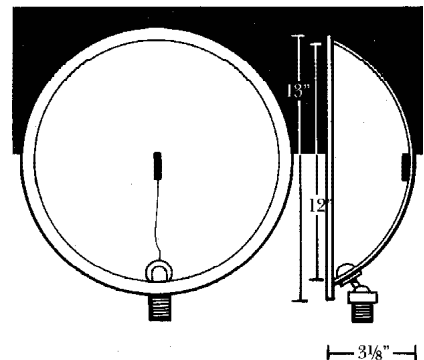

Fig. 35 – PZM dish.

PZM Dish

The PZM Dish has an uneven response on-axis, but is useful for its excellent directionality at mid-to-high frequencies. Dishes have been used over orchestral sections for isolation, and for long-reach speech applications.

The dish is not a parabolic microphone. The PZM is placed on the dish, rather than at the focus of a parabolic surface. The dish obtains its directionality from diffraction (blocking sound waves from certain directions), while a parabolic microphone obtains its directionality by focusing sound energy from a particular direction on the mic capsule.

$F_{-12}=250$ Hz.

Frequency response: See Fig. 33.

Polar pattern: See Fig. 34.

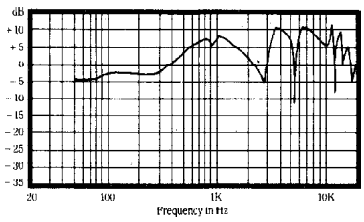

Fig. 33 – PZM dish frequency response.

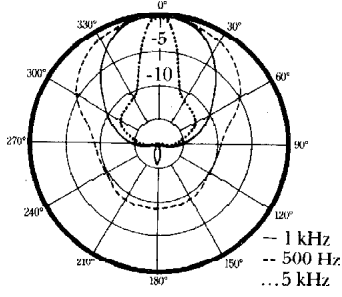

Fig. 34

PZM Cone

This model is highly directional and emphasizes mid-frequencies. It has been used as a “follow” mic for a roving TV camera, and provides a close-up audio perspective.

Random Energy Efficiency (for a cone with a 90-degree included angle) = -8.3 dB. The cone rejects reverb by 8.3 dB compared to an omnidirectional microphone in open space at the same distance.

Distance factor: 2.6. That is, the cone can be placed 2.6 times as far from the source as an omni mic for the same direct/reverb ratio.

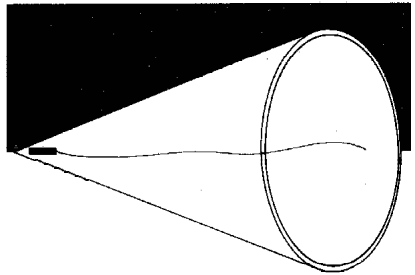

Fig. 36 – PZM cone. 1' long, 1' diameter

1560, 2260, 4060, 7260

These models have the same basic shape – two panels angled 60 degrees apart—but have different sizes. In general, the bigger the panels, the better the low-end response and the lower in frequency the directivity extends.

The 1560 is typically used on lecterns. Its response and polar patterns are shown in Figures 37, 38 and 39.

The 7260 has been used for stereo pickup of xylophones or brass sections. It is assembled in two halves for easier transport.

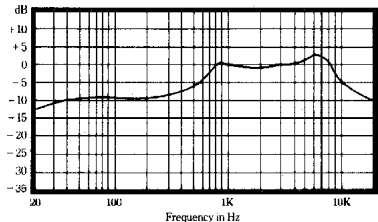

Fig 37 – Frequency response of PZM-6D on 1560 boundary.

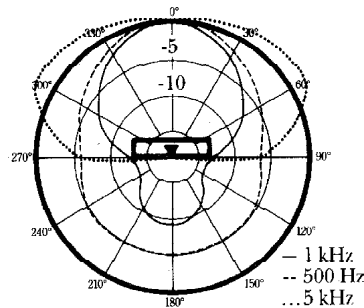

Fig 38 – 1560: horizontal-plane polar response.

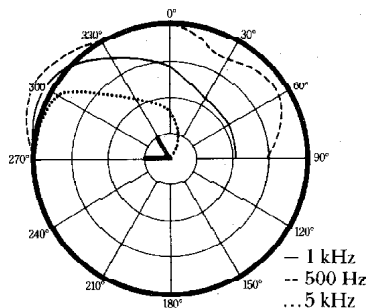

Fig. 39 – 1560: vertical-plane polar response.

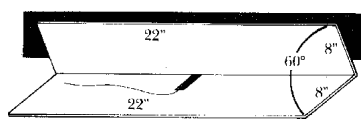

Fig. 40 – 2260

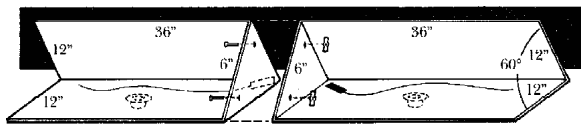

Fig. 41 – 7260

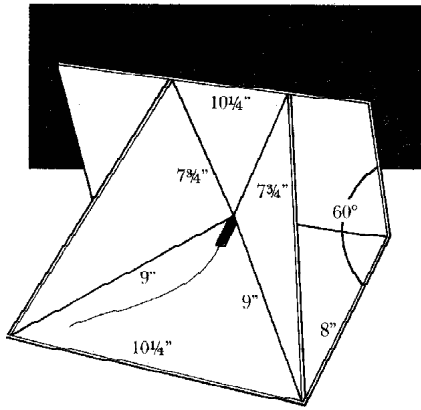

Fig. 42 – 1560 with side boundaries.

1560 with Side Boundaries

This is a basic 1560 modified with two side boundaries at 45 degrees on each side (Fig. 42). The side boundaries provide additional discrimination of loudspeakers to either side of the lectern.

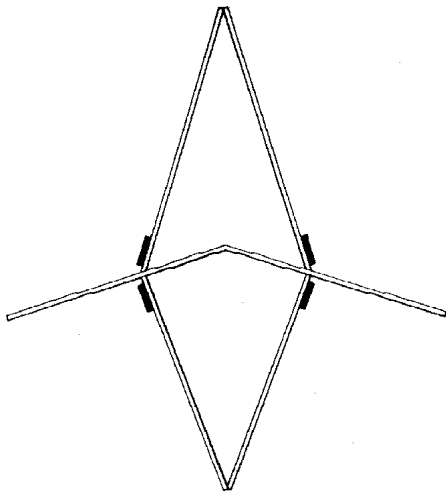

Fig. 43

L² Array

This multipurpose array (Fig. 43) was designed by recording engineer Mike Lamm. Mike has used this array extensively for overall stereo or surround pickup of large musical ensembles.

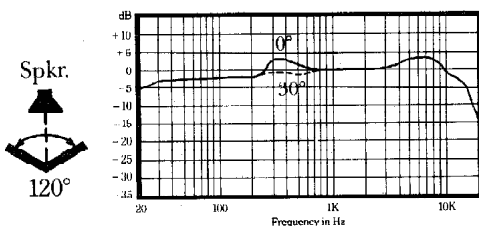

Fig. 44 – Frequency response of L² array (with PZM-6D capsule). 120° between boundaries.

The hinged, sliding panels can be adjusted to obtain almost any stereo pickup pattern. A complete description of the L² Array is in AES preprint 2025 (C-9), “The Use of Boundary Layer Effect Microphones in Traditional Stereo Miking Techniques,” presented at the 75th Convention of the Audio Engineering Society, October 1983. The frequency response is shown in Figures 45 and 46.

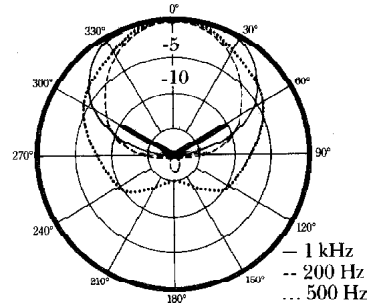

Fig. 45 – Polar response of L² array, 120° between boundaries.

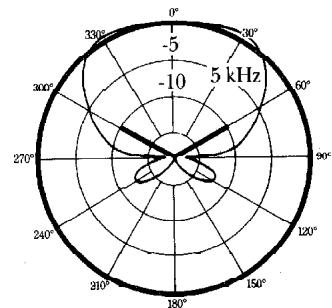

Fig. 46 – Polar response of L² array, 120° between boundaries.

L² Floor Array

Here’s another stereo PZM array (Fig. 47) designed by recording engineers Mike Lamm and John Lehmann. It simulates the O.R.T.F. stereo mic technique. According to one user, “You can take this array, set it down, and just roll. You get a very close approximation of the real event.”

Suspending the inverted array results in less bass and more highs, while placing it on the floor reverses the balance.

When this array is used on a stage floor, the construction shown in Fig. 48 is useful. It has decreased side pickup and increased pattern overlap. The axes of the left and right polar patterns may be at any desired angle, just so the 120° boundary angle and 6.7-inch capsule spacing are maintained.

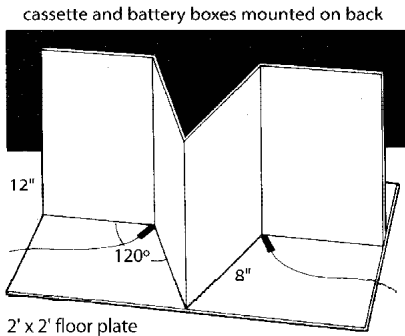
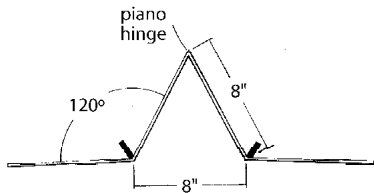

Fig. 47 – L² floor array – designed by Mike Lamm and John Lehmann can be set on the floor, set on a C stand or hung inverted from the ceiling.

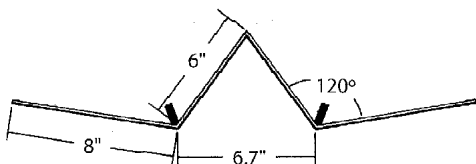

Fig. 48 – Another version of the L² floor array.

PZM Wedge or Axe

This stereo PZM array has been used extensively by recording engineers Mike Lamm and John Lehmann. It simulates the O.R.T.F. stereo microphone technique. Stereo imaging is precise and coverage is even.

Place the mic capsules 2½" below the center of the panels to smooth the frequency response. To compensate for the bass shelving of the panels, boost the bass +6 dB at and below 141 Hz.

A panel containing a 5/8"-27 Atlas flange can be fastened to the bottom of the array for stand mounting.

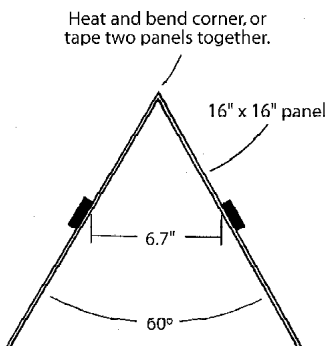

Fig. 49 – PZM wedge or axe (top view).

Aim the point of the wedge at the center of the sound source, and raise the array about 14 feet off the floor.

The wider the angle between boundaries, the more frontal is the directivity. Increasing the angle makes the sound source appear to be closer to the listener. The array is mono compatible to a great extent.

A wedge used by Gary Pillon of General Television Network, Detroit, uses 2'-square panels. The mics are 4" off-center toward the point of the "V". To compensate for bass shelving of these panels, boost the bass +3 dB at 94 Hz.

Pillon Stereo PZM Array

This stereo PZM array was devised by Gary Pillon, a sound mixer at General Television Network of Detroit, Michigan. A documentary recording he made with this array won an Emmy. The assembly can be stand-mounted from the backside or handheld, if necessary.

The stereo image, which is partly a result of the 8" capsule spacing, is designed to be like that produced by a binaural recording, but with more realistic playback over loudspeakers. Ideally, this device would mount on a Steadicam platform and give an excellent match between audio and video perspectives.

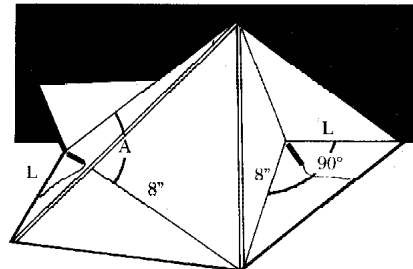

Fig. 50 – Pillon stereo PZM
L = 8" and A = 90° for speech use
L = 12" and A = 120° for music use

THE SASS® PZM STEREO MICROPHONE

As explained earlier, one way to record in stereo with PZMs is to mount two PZMs on a wedge: two 2'-square panels, angled apart to form a "V". This arrangement can be cumbersome. But recent research has led to a unique application using PZMs on a smaller head-size boundary: The Crown SASS microphone.

The Crown SASS® or Stereo Ambient Sampling System is a new kind of stereo microphone. It does an excellent job recording sounds in stereo, such as:

- orchestras, choirs, symphonic bands, pipe organs
- news events
- sports ambience and crowd reaction
- background sounds for films
- stereo samples for keyboards
- stereo sound effects

Before explaining how the SASS makes such good stereo recordings, let's describe how stereo itself works.

How Stereo Works

Normally you listen to stereo over two speakers, one placed in front of you to the left, and one to the right.

When you listen to a stereo recording of an orchestra, you can hear strings on the left, basses on the right, and woodwinds in the middle. That is, you hear an image of each instrument in certain locations between speakers (Fig. 51).

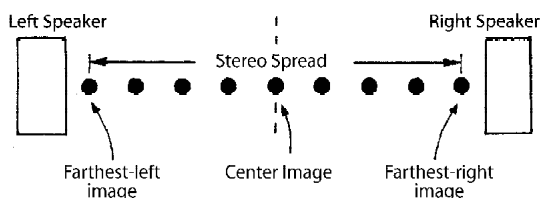

Fig. 51 – Stereo images.

If you send the same audio signal to the two speakers, you hear an image in the middle between the two speakers.

How do recording engineers make the images appear left or right?

One way is to make the signal louder in one channel than the other. For example, if you feed the same signal to both channels, but turn up the volume of the right channel, the image shifts to the right speaker.

Another way is to delay the signal in one channel. If you feed the same signal to both channels, but delay the left channel one millisecond, the image shifts to the right speaker.

So, various image locations can be created by recording loudness differences and/or time differences between channels. We want a sound source on the right to make a louder signal in the right channel than the left. Or we want a sound source on the right to make a signal sooner in the right channel than the left.

This is done with stereo microphone techniques. There are three basic stereo techniques; coincident pair, spaced pair, and near-coincident pair.

With coincident-pair miking, a pair of directional microphones is placed with grilles touching, one mic above the other, and angled apart (Fig. 52). A sound source toward the right will produce a stronger signal from the mic aiming toward it than from the mic aiming away from it. Thus, the right channel will be louder and you'll hear the image to the right.

With spaced-pair miking, a pair of microphones is placed several feet apart, aiming straight ahead (Fig 53). Sounds from a source toward the right will reach the right mic sooner than the left mic, simply because the

right mic is closer to the sound source. Thus, the left channel will be delayed and you'll hear the image to the right.

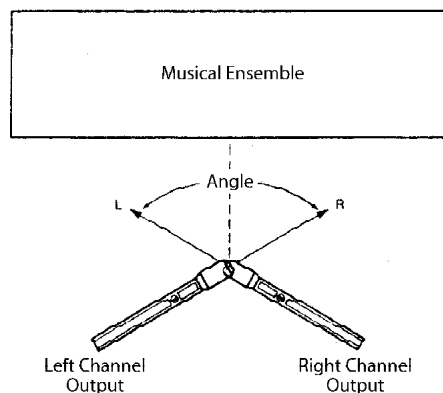

Fig. 52 – Coincident-pair stereo miking.

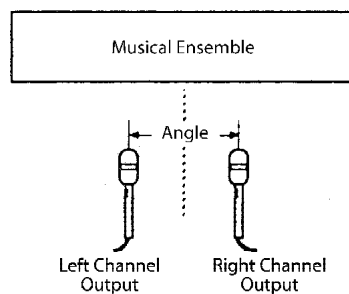

Fig. 53 – Spaced-pair stereo miking.

With near-coincident miking, a pair of directional microphones is angled apart and spaced apart a few inches horizontally (Fig. 54). A sound source on the right will be louder in the right channel AND delayed in the left channel. These two effects add together, so you'll hear the image to the right.

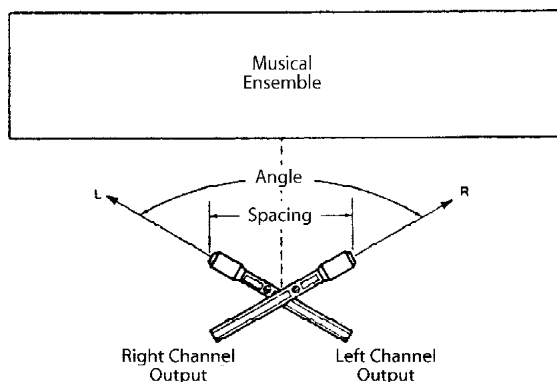

Fig. 54 – Near-coincident stereo miking.

How the SASS Works

Back to the SASS. It uses two small microphones spaced a few inches apart. Each microphone is on a surface that blocks sound from the rear, and these surfaces are angled apart (Fig. 55). In other words, the surfaces make the microphones directional. So the SASS is like a near-coincident pair, in which two directional mics are angled apart and spaced horizontally a few inches.

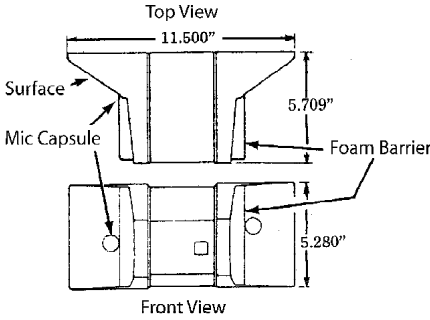

Fig. 55 – Parts of SASS

The surfaces make the microphones directional only at mid-to-high frequencies. At low frequencies, the microphones pick up all around them—they are omnidirectional.

The SASS produces stereo in different ways at different frequencies. At low frequencies, the SASS acts like a spaced pair, producing time differences between channels to make a stereo effect. At high frequencies, the SASS acts like coincident pair, producing mostly loudness differences between channels to make a stereo effect. At mid-frequencies, the SASS acts like a near-coincident pair, using both loudness and time differences to make stereo.

This is the same way the human hearing system works. Our ears are omnidirectional at low frequencies, directional at high frequencies (because the head blocks sounds), and are spaced apart a few inches.

Since the SASS hears sounds the same way our ears do, it produces very natural stereo with easy-to-localize images. It also gives a pleasing sense of spaciousness, a sense of the environment in which the sound was recorded. Both these attributes can be heard over loudspeakers or over headphones.

The coincident-pair method gives a narrow stereo spread over headphones. The spaced-pair method makes images that are poorly focused or hard-to-localize when heard with speakers (Fig. 56). The SASS has neither of these problems. It gives accurate, wide stereo over headphones, and makes images that are sharp and correctly placed when heard with speakers or headphones.

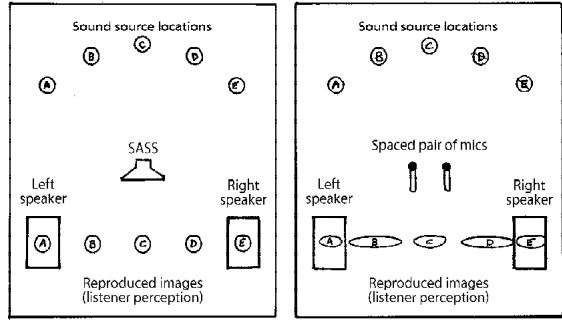

Fig. 56

The SASS Is Mono Compatible

It's important for stereo recordings to be mono compatible. That is, the tone quality must be the same whether the program is heard in mono or stereo.

With spaced-pair or near-coincident recordings, the microphones are spaced apart. Sound arrives at the two microphones at different times. Thus, the left and right signals are in phase at some frequencies, and out-of-phase at other frequencies. If the two channels are combined for mono listening, the out-of-phase frequencies cancel out. This makes dips in the frequency response (Fig. 57). The non-flat response gives a filtered, colored tone quality to whatever is recorded.

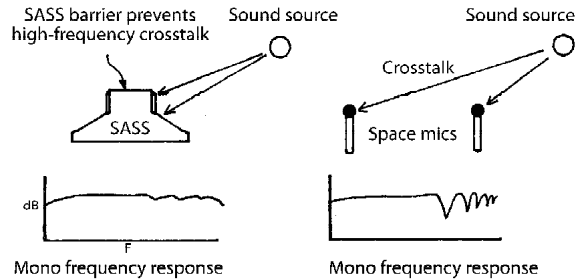

Fig. 57

Recordings made with the SASS do not have this problem. That's because it's made with a special block of dense foam between the mic capsules. This foam barrier absorbs sound. It prevents sound from the right side from reaching the left microphone, and vice versa. Thus, the signal is much louder in one channel than the other.

For a phase cancellation to be complete when two channels are combined to mono, the levels in both channels must be about the same. But the levels in both channels are different in the SASS (due to the foam barrier between capsules), so phase cancellation in mono is relatively slight (Fig. 57). Thus the tone quality stays the same in stereo or mono with the SASS.

Better Bass Response

All directional microphones have reduced output in the deep bass. Thus, stereo methods that use directional

mics have weak deep bass. The SASS does not have this problem because it is not directional at low frequencies. It has excellent bass response extending to 20 Hz.

Simple to Use

Mid-side stereo microphones require a matrix box between the microphone and recorder. This box converts the mid and side signals from the microphone to left and right signals for stereo recording. The SASS already has left and right outputs, so it needs no in-line matrix box.

It's easy to tell where to aim the SASS by looking at it. In contrast, some stereo microphones are difficult to aim properly.

Excellent Performance

The SASS has very wide-range, smooth frequency response (20 Hz–18 kHz), and very low pickup of mechanical vibrations and wind noise.

Summary

The SASS is a stereo microphone using PZM® technology. The unit provides excellent stereo imaging, has a natural tonal balance, is mono-compatible, is easy to use, and costs less than the competition. It comes with a carrying case and a full line of accessories.

HOW TO USE THE SASS

Do not place the SASS closer than 3 feet from the sound source, or the center image will be weak or muffled (Fig. 58).

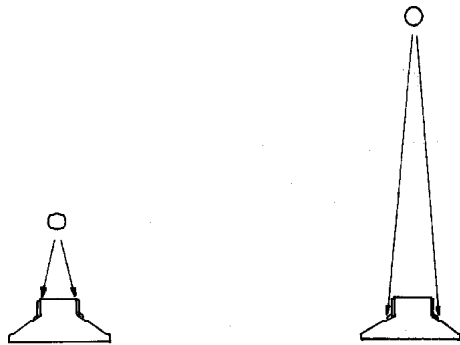

Center sound source too close to SASS: mic capsules can't "hear" it, because its sound is blocked. Result: weak center image.

Center sound source far from SASS: both mic capsules hear it. Results: strong center image.

Fig. 58

In live-to-2-track recording, we recommend that the final placement decisions be made while monitoring on loudspeakers for more-accurate imaging.

If the correctly monitored stereo spread is excessive (because of close mic placement), run the SASS signals through a stereo mixer with pan pots, and pan the two channels toward center until the stereo spread is correct. This can be done during recording or post-production.

Large musical ensembles (orchestra, band, choir, pipe organ)

Place the SASS 4 to 15 feet from the front row of musicians. Angle it down so that it will be aimed at the performers when raised, and raise it about 15 feet high on a microphone stand (Fig. 59). Closer placement to the performers will sound more edgy, detailed, and dry; farther placement will sound more distant, blended and reverberant. Try to find a spot where you hear a pleasing balance between the direct sound from the ensemble and the hall ambience.

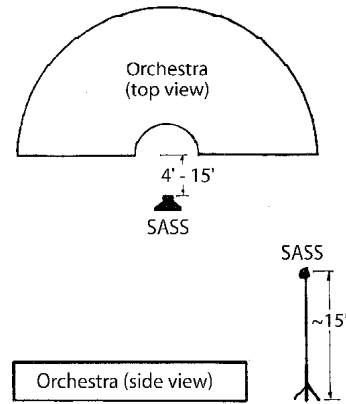

Fig. 59

Because the SASS is quite sensitive to the sides as well as the front, closer placement will not be as dry as with directional microphones. Hence, the SASS can be placed into an ensemble farther than is ordinarily possible, providing greater detail and spread, if that is desired, without feeling forced or unnatural. The center of the sound image and the hall reverberation are still retained.

If you are recording a choir that is behind an orchestra, experiment with the stand height to find the best balance between the two sources. The strings project upward while the choir projects forward, so you might find a better balance at, say, 9 feet high rather than 15 feet.

Small musical ensemble or soloist (quartet, small combo, background harmony vocals, solo piano, harp, or guitar)

Place the SASS 3 to 8 feet away at ear height. Move closer for less reverb and noise, farther for more hall acoustics. For a grand piano, place the SASS in-line with the lid. Placement near the hammers sounds more trebly; placement near the tail sounds more bassy.

Drum set

See Fig. 60. Place the SASS above the level of the snare drum, below the cymbals, aiming at the snare drum about 3 feet away, midway between the mounted tom and floor tom. You may need to boost a few dB around 10 kHz - 15 kHz. Add another microphone of your choice in the kick drum. The SASS also works well as an overhead mic.

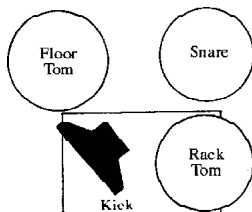

Fig. 60

Samples and sound effects

If you sample a sound source in a particular off-center position, the SASS will accurately reproduce the image location. Recorded ambience will sharpen the image, but is not necessary.

If you record ambience along with the sample, the ambience will be reproduced whenever the sample is played. So you may want to make several samples of one source at different distances to include the range of added reverberance or ambience.

Suppose you're sampling in stereo and picking up ambience. If the sample is pitch-shifted, the direction of the images and perceived size of the room will be affected by most pitch-changing algorithms. You can minimize these effects by sampling at intervals of one-third octave or less.

When looping, try to control the room ambience so it is consistent before and after the sample (unless reverberant decay is desired as part of the sample).

When recording a moving sample or effect, experiment with the distance between the microphone and the closest pass of the sound source. The closer the SASS is to the path of the subject, the more rapidly the image will pass the center point (almost hopping from one channel to the other). To achieve a smooth side-to-side movement, you may need to increase the distance.

Moving vehicles (car hood, handlebars)

We recommend that you devise a shock-mount system to be used under the microphone. Also be sure to put on the windscreen, and enable the low-cut switch (or use low-cut filters in your mixer).

Electronic News Gathering (E.N.G.)

You can often record an announcer and ambience with the SASS alone, without an extra handheld or lavalier mic on the announcer. If the ambient noise level is too high, use a mixer to blend a close-up microphone (panned to center) with the SASS.

The SASS will give a slight but not noticeable boost to the appropriate side if the talent moves away from frame center. If the SASS is camera mounted, use the windscreen to subdue wind noise caused by camera movement.

Because of its light weight, the SASS can be mounted on a fishpole, floor stand, boom stand, or tripod, in addition to the handgrip.

CHOOSING THE RIGHT CROWN BOUNDARY MICROPHONE

Application	Suggested Model
Recording	PZM-30D Rugged, use with detachable cable. PZM-6D Inconspicuous, permanently attached cable.
Multiple Boundary Recording/P.A.	PZM-6D Unscrew cantilever from plate.
Stereo Recording	SASS-P MK II Stereo PZM microphone.
Stage Floor	PCC-160
Conference Table	PCC-170 Supercardioid. PCC-170SW Supercardioid with push on/off membrane switch. PCC-130 Small cardioid. PCC-130SW Small cardioid with push on/off membrane switch. Mini Boundary Microphones : Very small mics with a half-supercardioid pattern. Five models are available: MB-1 : Plugs into a brass cup in the table. MB-2 : Plugs into a jack in the table. MB-3 : Tubular; mounts in ceiling, wall or table. MB-4 : For temporary use. Has a thin cable with XLR connector. MB-4E : Lowest cost. Cable fits through small hole in table.
Models MB-1, MB-2, and MB-4E require an MB-100 or MB-200 interface. The MB-200 interface allows remote sensing of switch closure, so it can be used with a video switcher.	
Piano Sound Reinforcement	PZM-30D, PZM-6D or PCC-160 on underside of lid.
Ambience	PZM-30D or PZM-6D on walls.
Security/Surveillance	PZM-11, PZM-11LL, PZM-10, PZM-10LL